

1

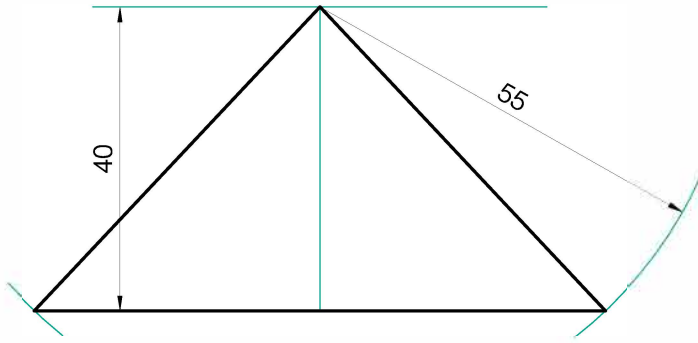

2

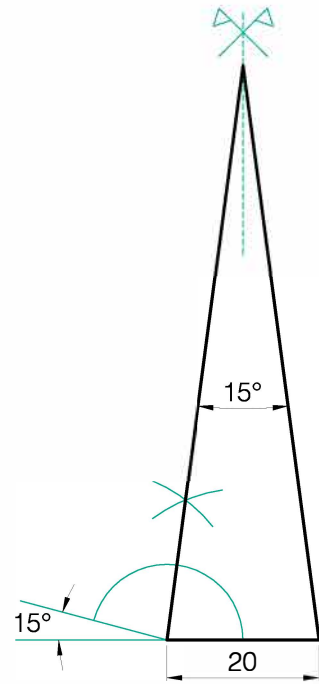

3

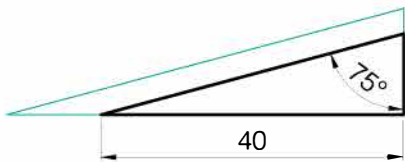

4

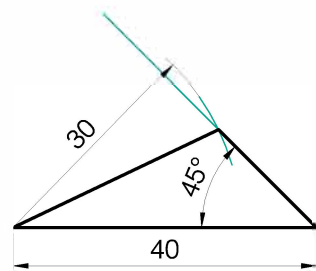

T3

Polígonos

EJERCICIOS
1, 2, 3 y 4

NOMBRE

FECHA

NOTA



La libreta
ACADEMIA

5

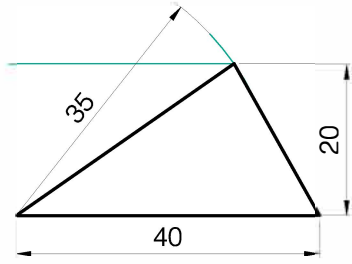

7

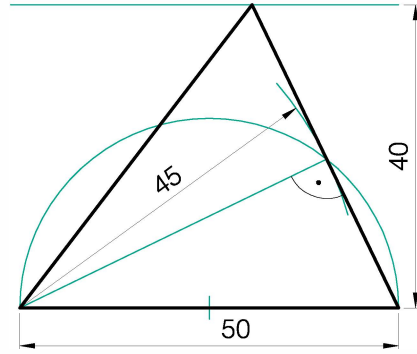

6

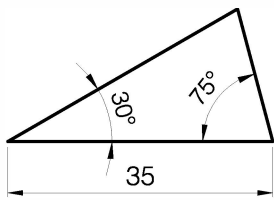

8

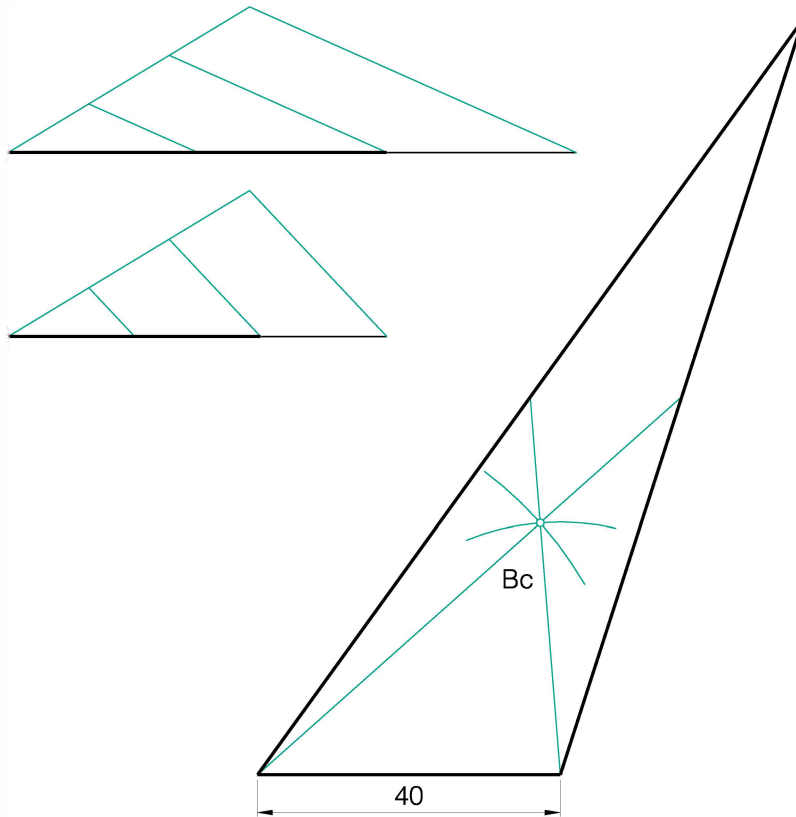

T3

Polígonos

EJERCICIOS
5, 6, 7 y 8

NOMBRE

FECHA

NOTA

La libreta
ACADEMIA

9

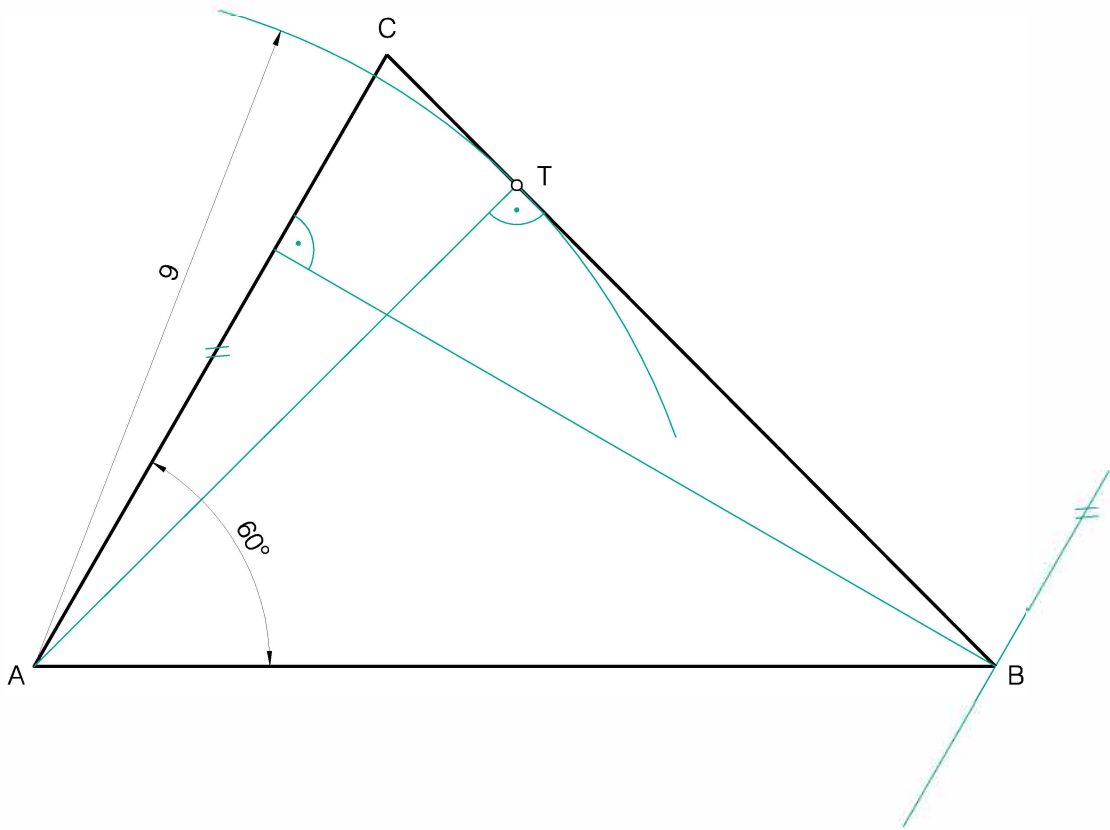

10

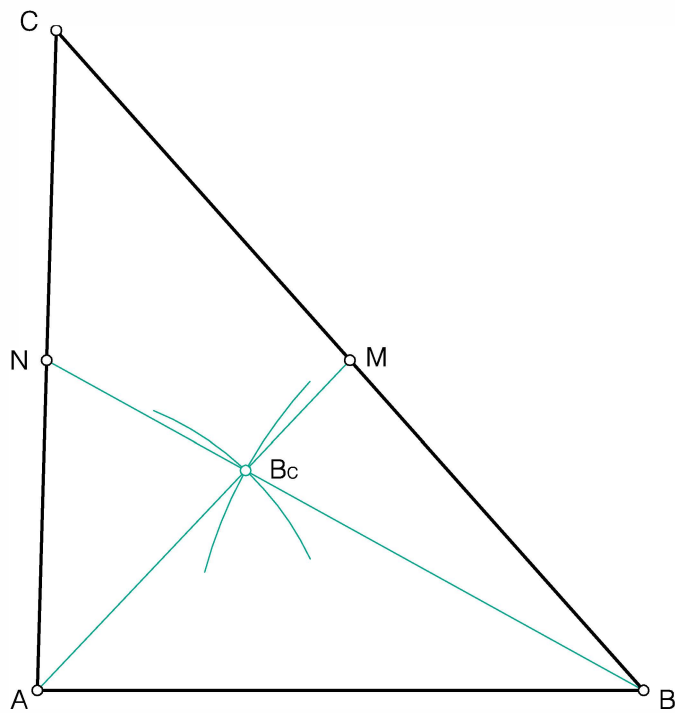

T3

Polígonos

EJERCICIOS
9 y 10

NOMBRE

FECHA

NOTA



La libreta
ACADEMIA

11

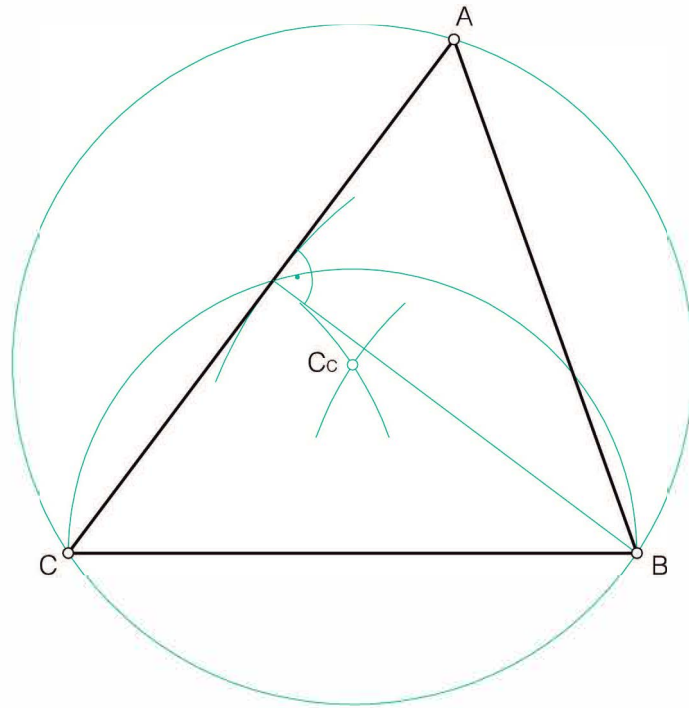

12

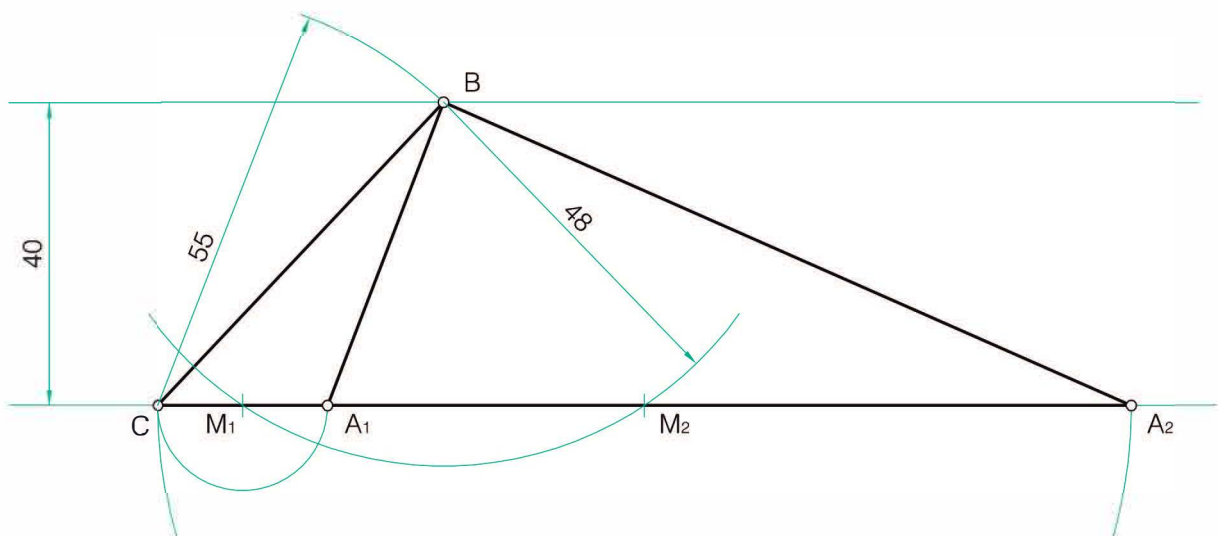

T3

Polígonos

EJERCICIOS
11 y 12

NOMBRE

FECHA

NOTA

14

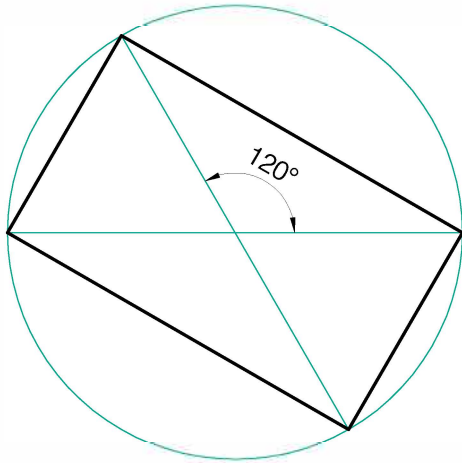

15

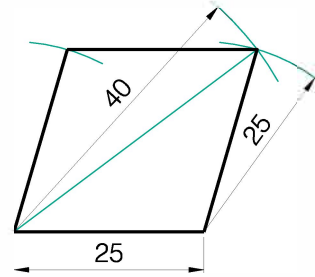

16

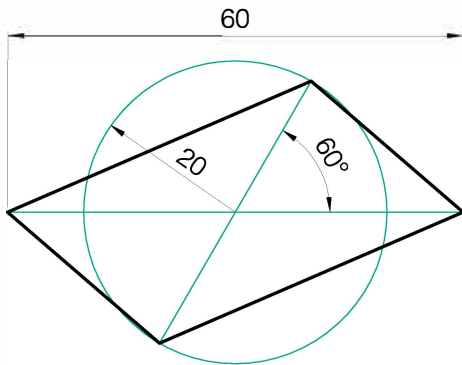

17

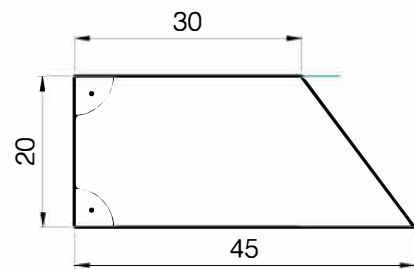

T3

Polígonos

EJERCICIOS
14, 15, 16 y 17

NOMBRE

FECHA

NOTA

La libreta
ACADEMIA

18

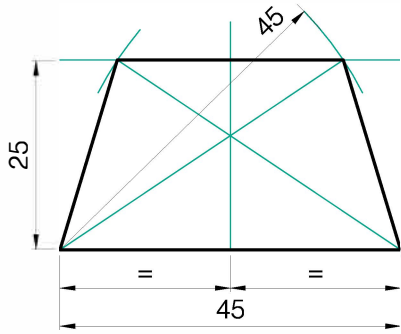

19

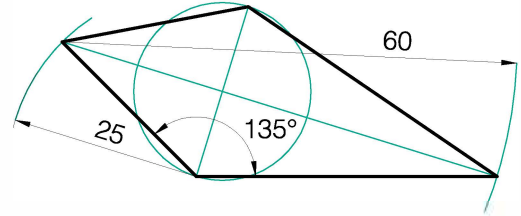

20

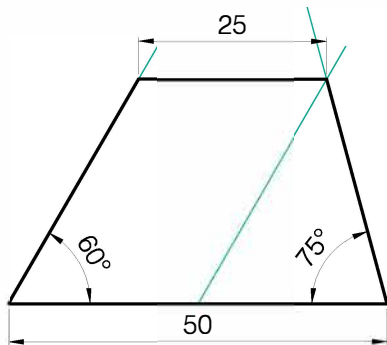

21

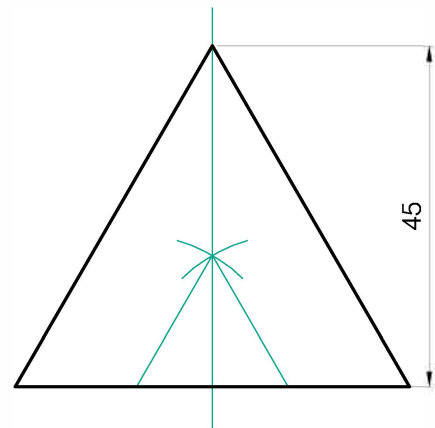

T3

Polígonos

EJERCICIOS
18, 19, 20 y 21

NOMBRE

FECHA

NOTA

La libreta
ACADEMIA

22

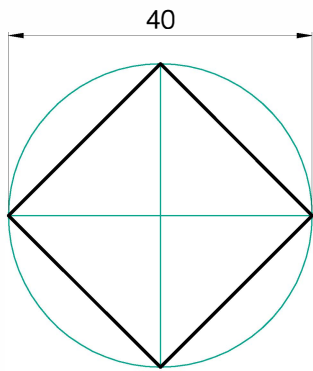

23

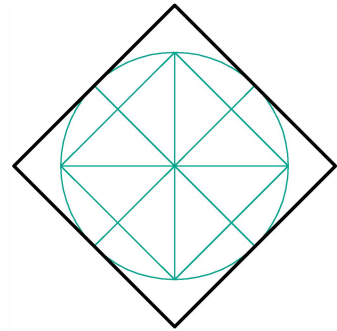

24

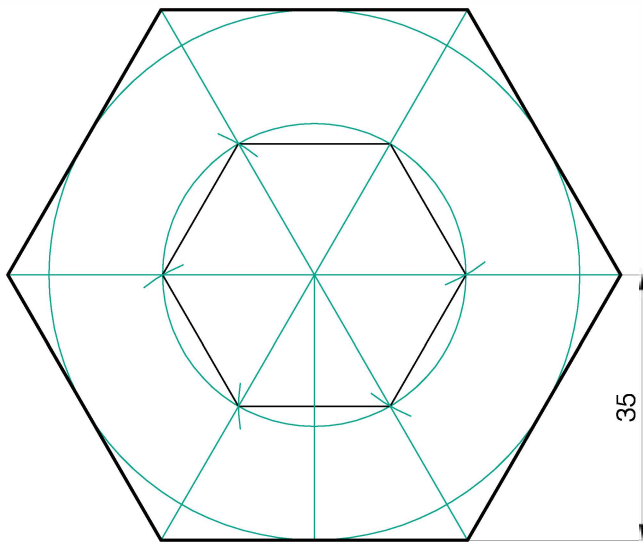

25

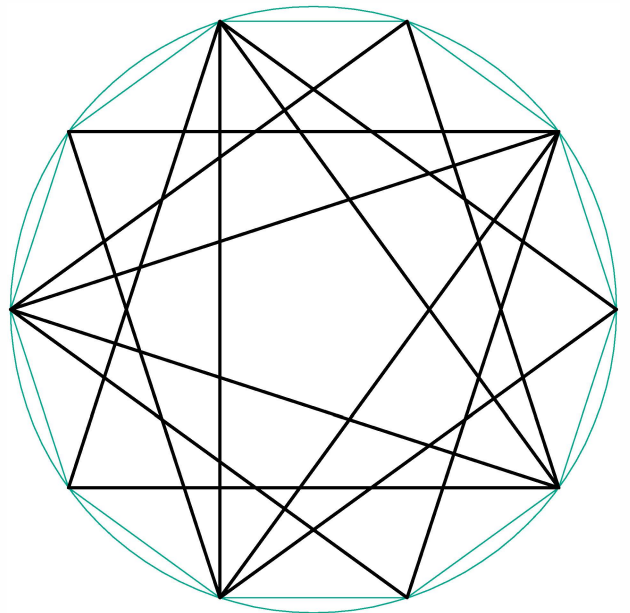

T3

Polígonos

EJERCICIOS
22, 23, 24 y 25

NOMBRE

FECHA

NOTA



La libreta
ACADEMIA

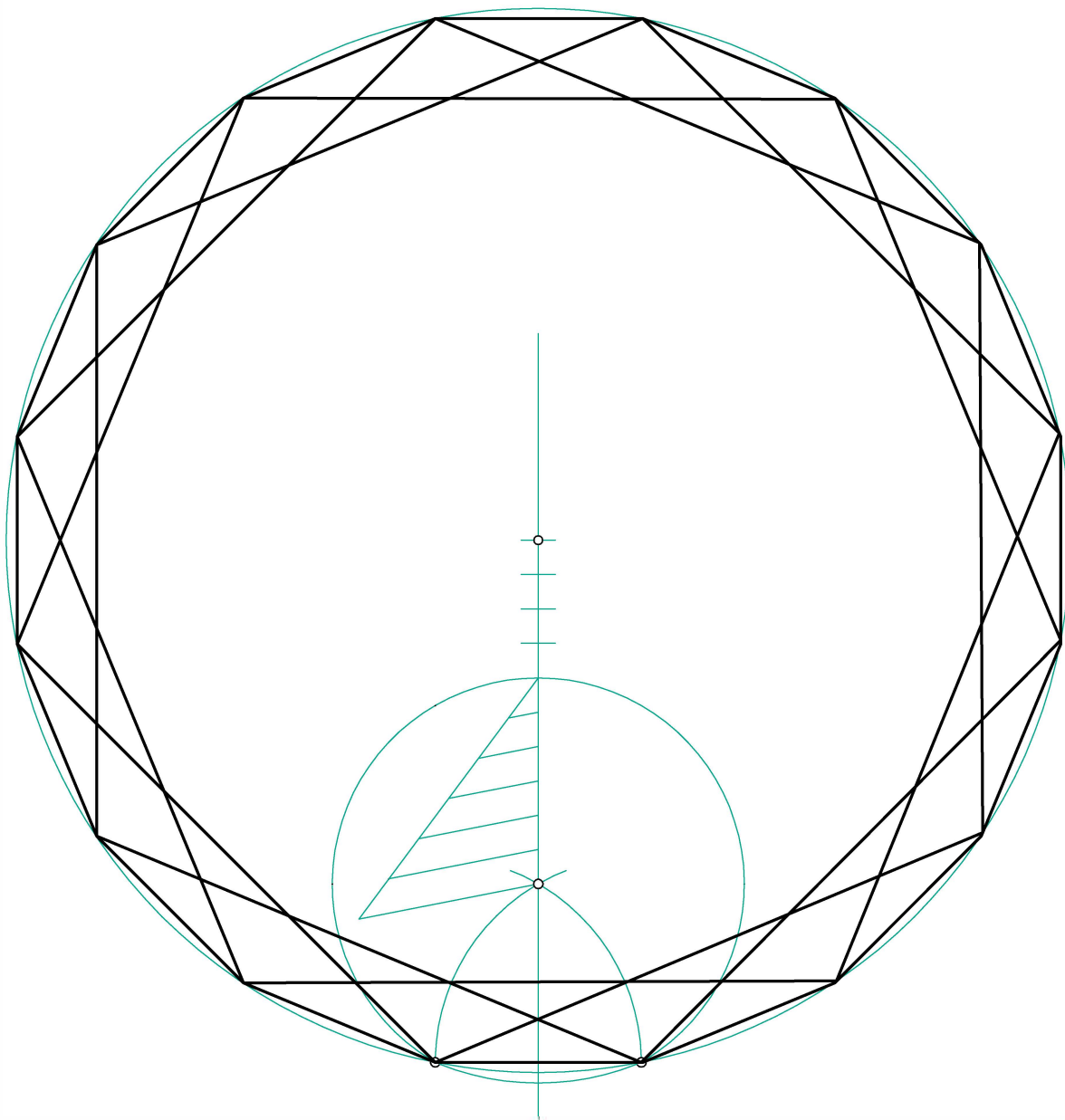

T3	Polígonos	EJERCICIO 26
NOMBRE	FECHA	NOTA

$AB = 100$
 Ángulo $ABC = 30^\circ$
 ma (mediana) = 110
 $AE \frac{3}{4}$ de DE
 Ángulo $DEF = \text{ángulo } ACB$
 Radio de la circunferencia circunscrita
 al triángulo $CAG = 50$
 h (altura) = 65
 mb (mediana) = 135
 mc (mediana) = 90
 Punto D incentro del triángulo ABC

Cotas en milímetros

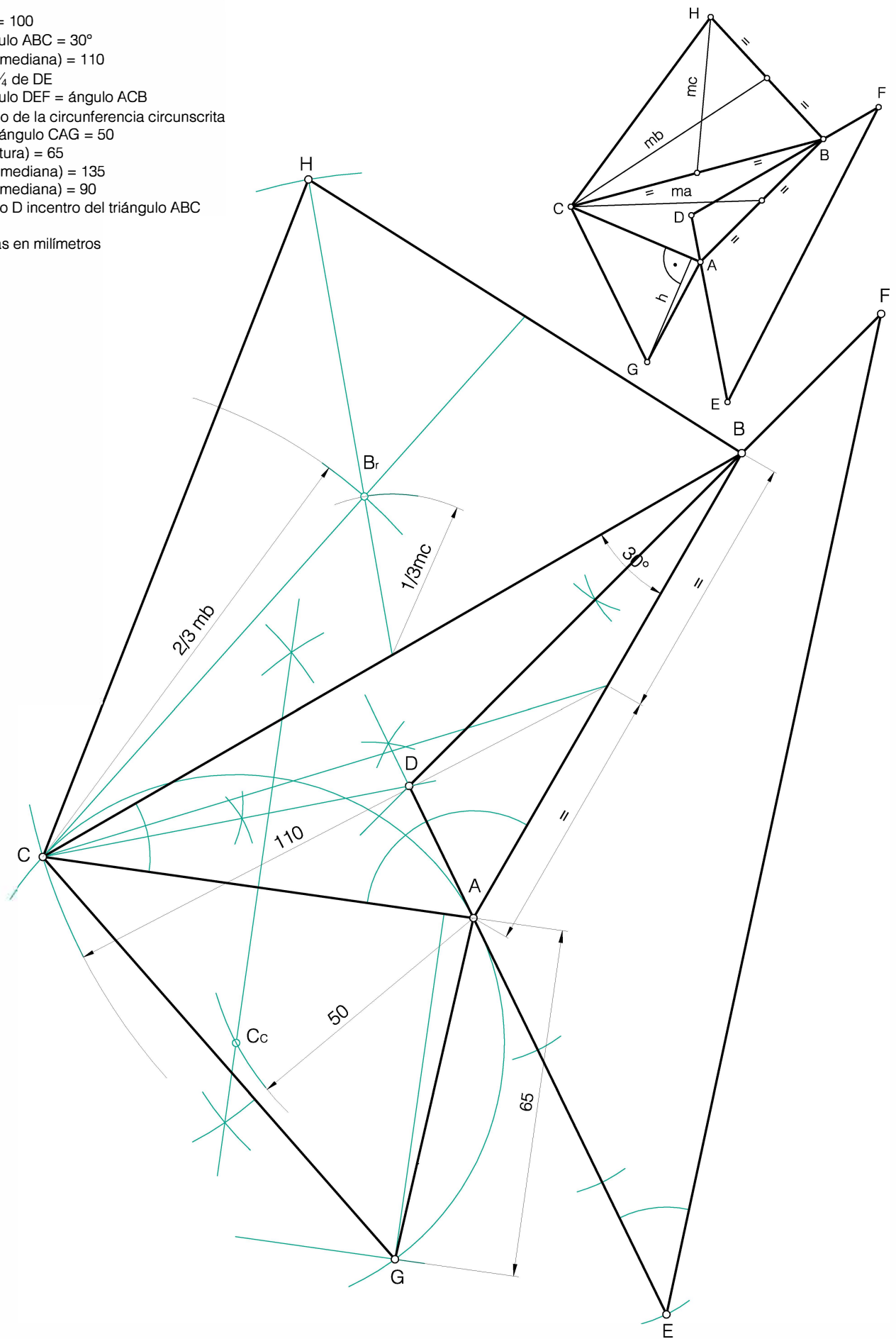

T3

Polígonos

FIGURA

50

NOMBRE

FECHA

NOTA



La libreta
ACADEMIA

$AB = 80$
 $\text{Ángulo } ABC = 90^\circ$
 $ma \text{ (mediana)} = 90$
 Punto D incentro del triángulo ABC
 $AD = \frac{2}{3} \text{ de } DE$
 Radio de la circunferencia circunscrita
 al triángulo EFB = 70
 $h \text{ (altura)} = 70$

Cotas en milímetros

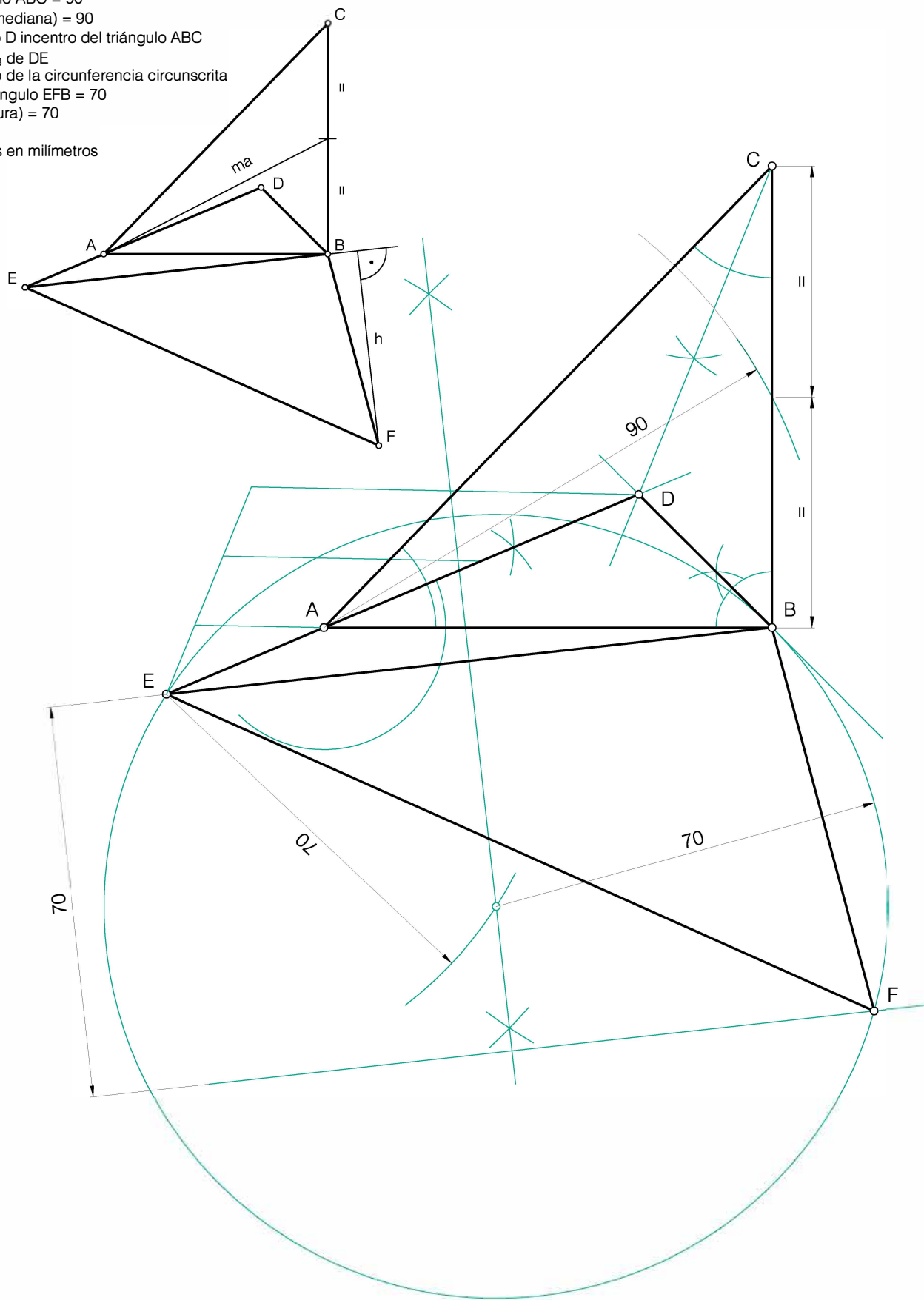

T3	Polígonos	FIGURA 51
NOMBRE		FECHA
		NOTA

Ángulo BAC = 30°
 Ángulo ABC = 60°
 ma (mediana) = 60
 ha (altura) = 60
 hb (altura) = 48
 hc (altura) = 72
 mb (mediana) = 60

Cotas en milímetros

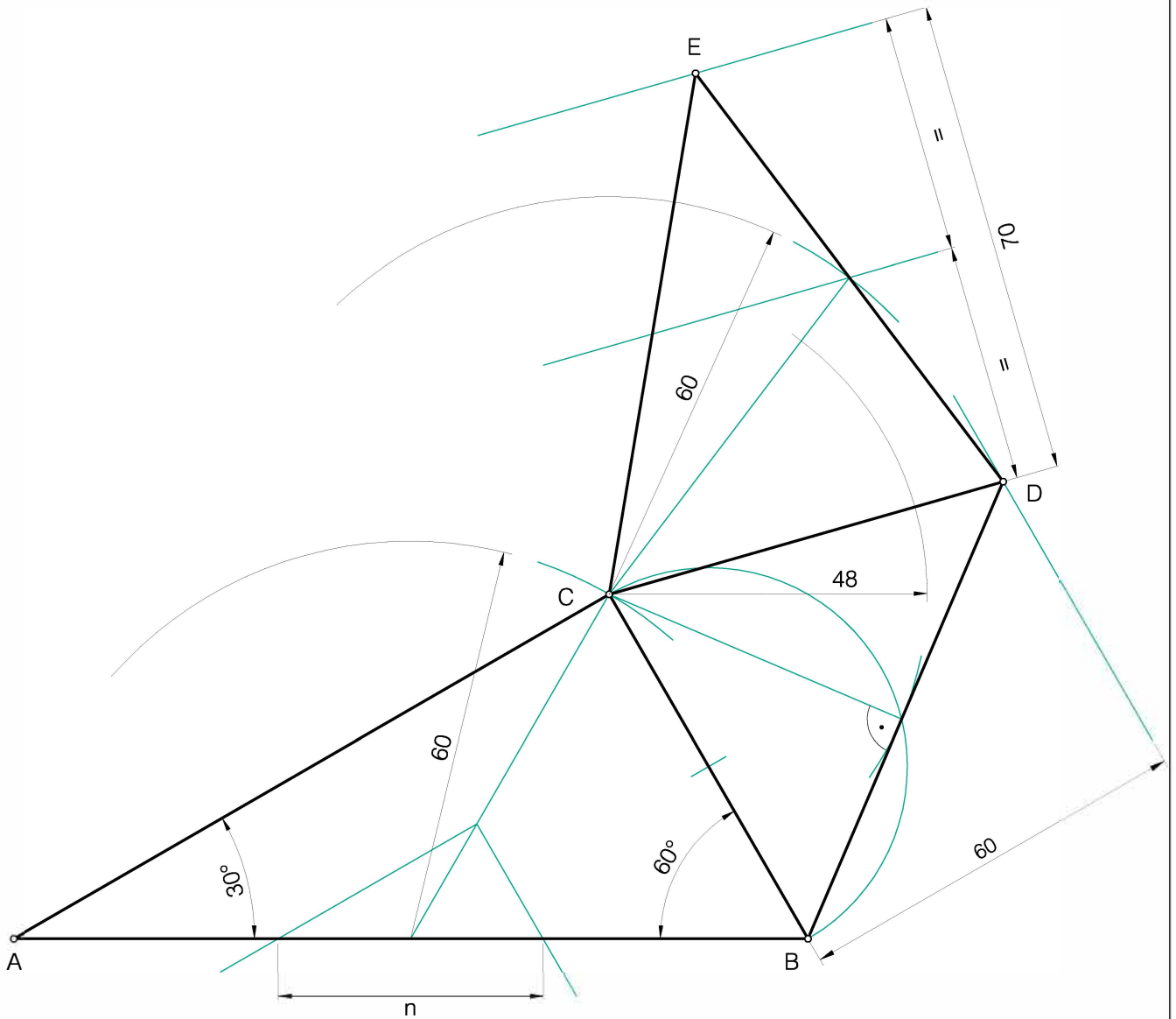
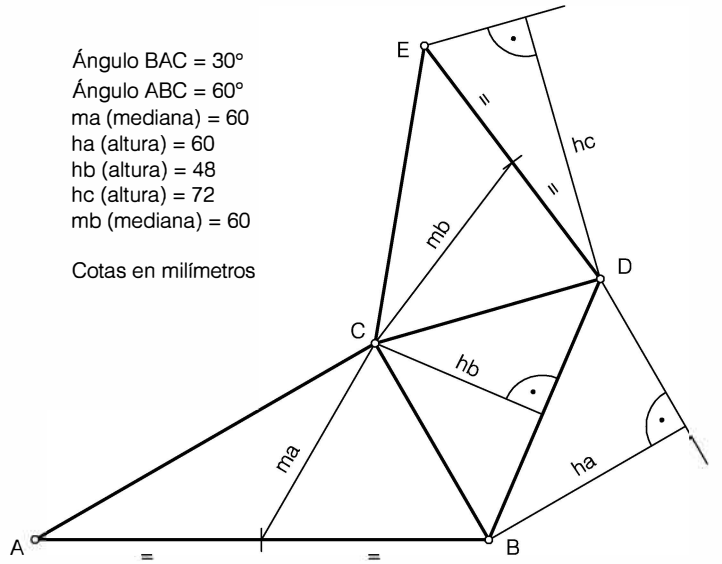

T3

Polígonos

FIGURA
52

NOMBRE

FECHA

NOTA



La libreta
ACADEMIA

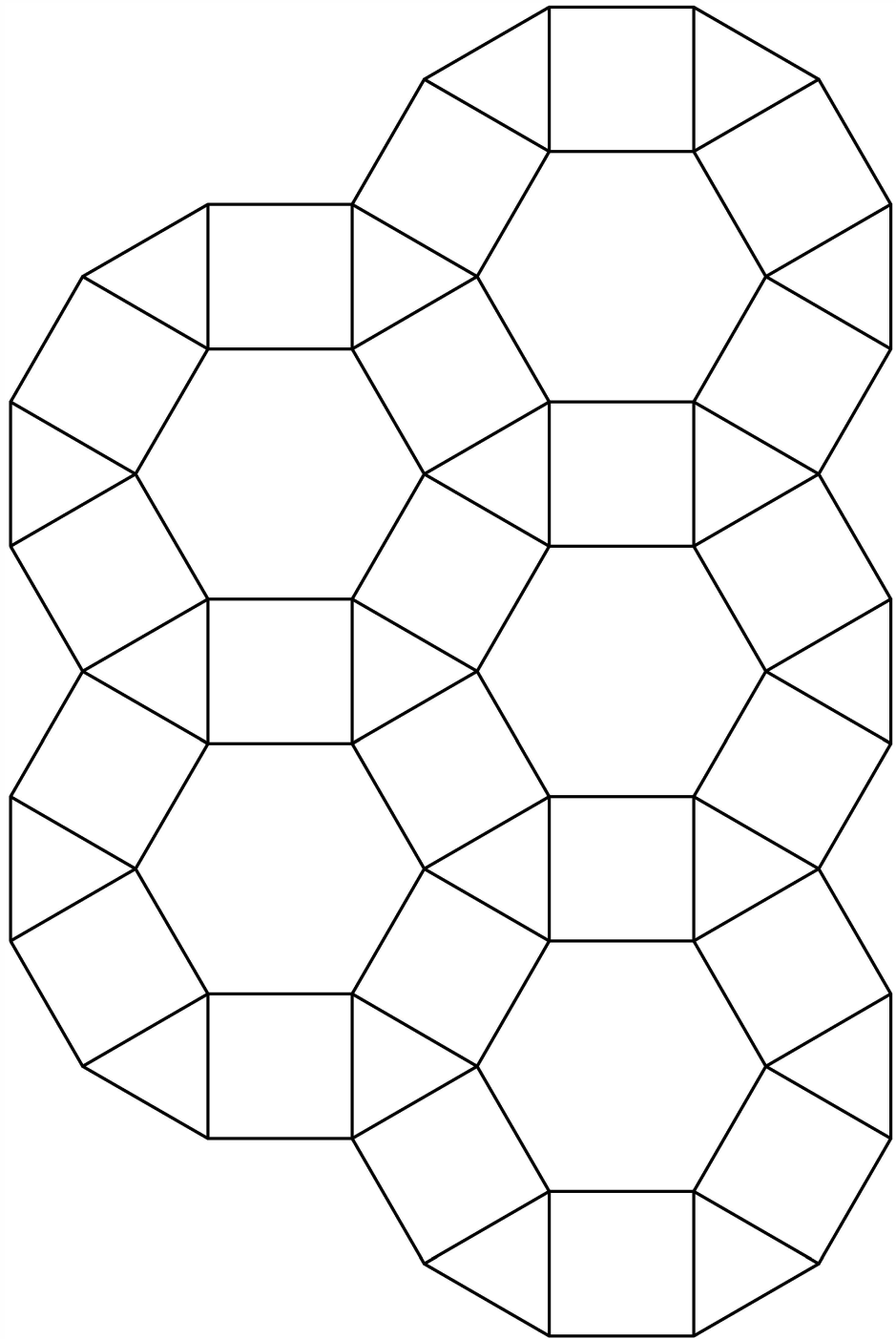

T3

Polígonos

FIGURA

53

NOMBRE

FECHA

NOTA



La libreta
ACADEMIA

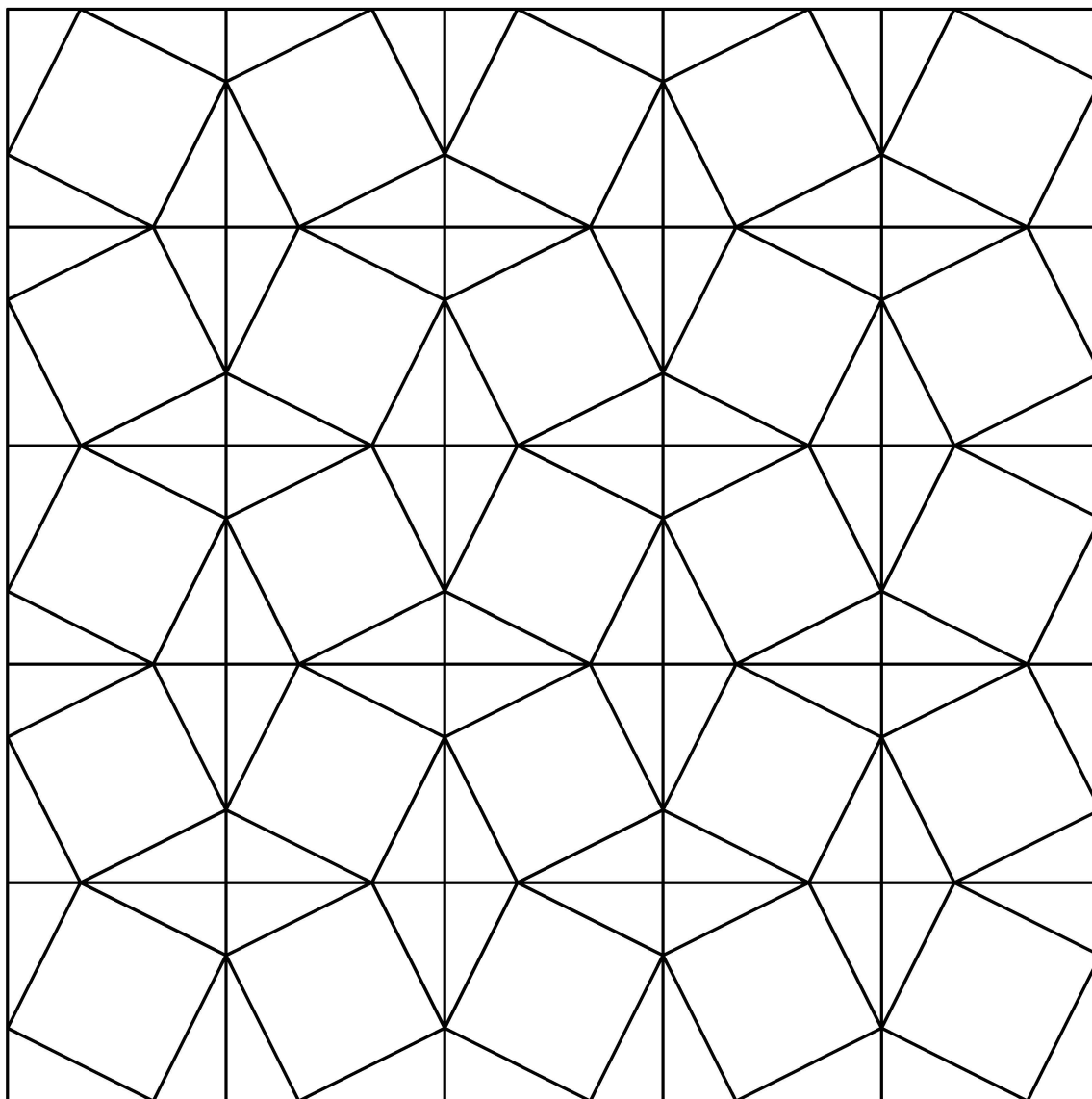

T3

Polígonos

FIGURA

54

NOMBRE

FECHA

NOTA



La libreta
ACADEMIA

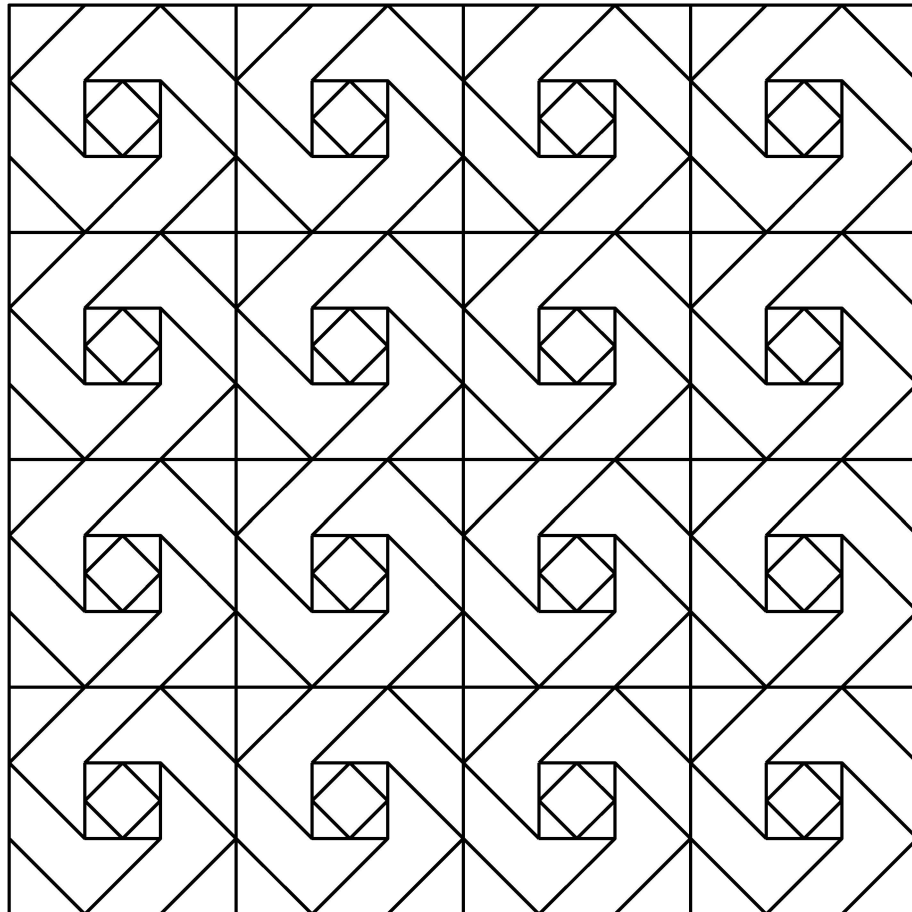

T3

Polígonos

FIGURA
55

NOMBRE

FECHA

NOTA



La libreta
ACADEMIA